

Fig. 3

Fig. 18
3.9

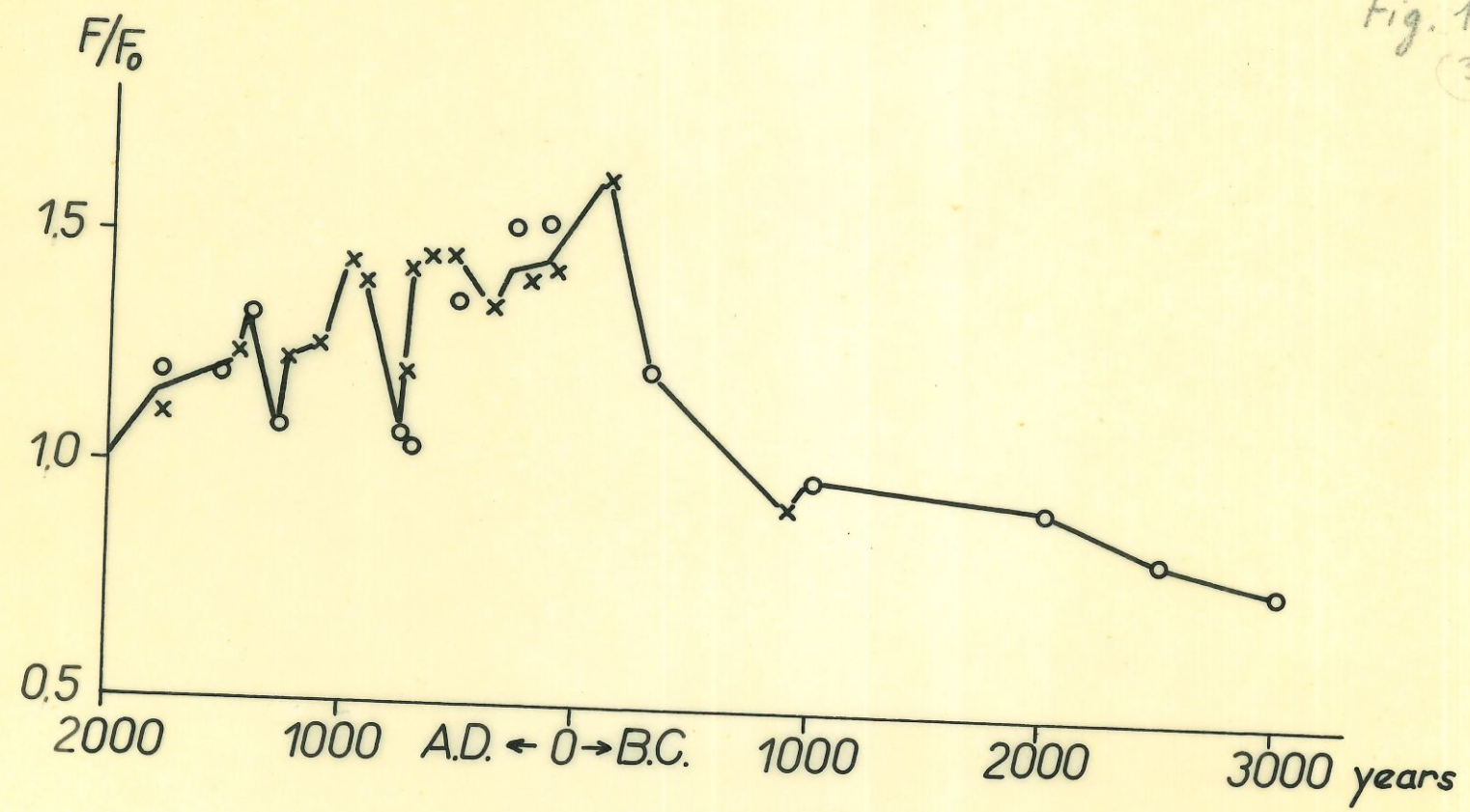

Fig. 16
(3.7)

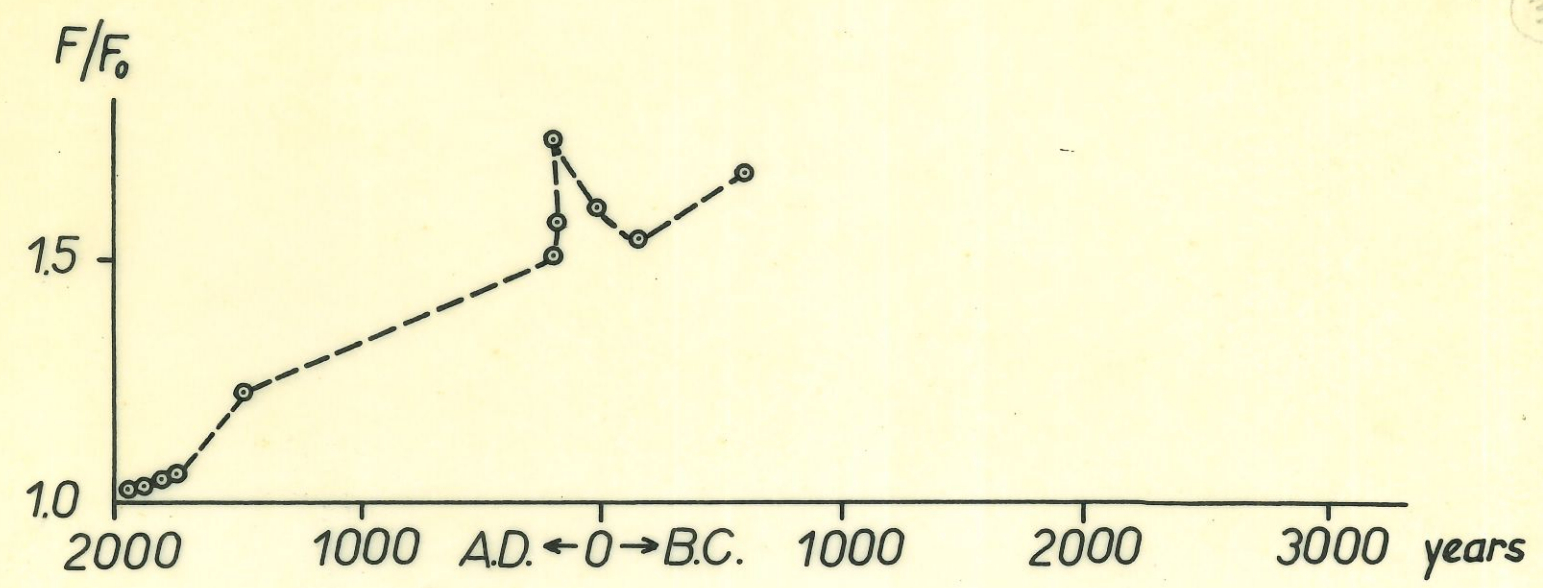
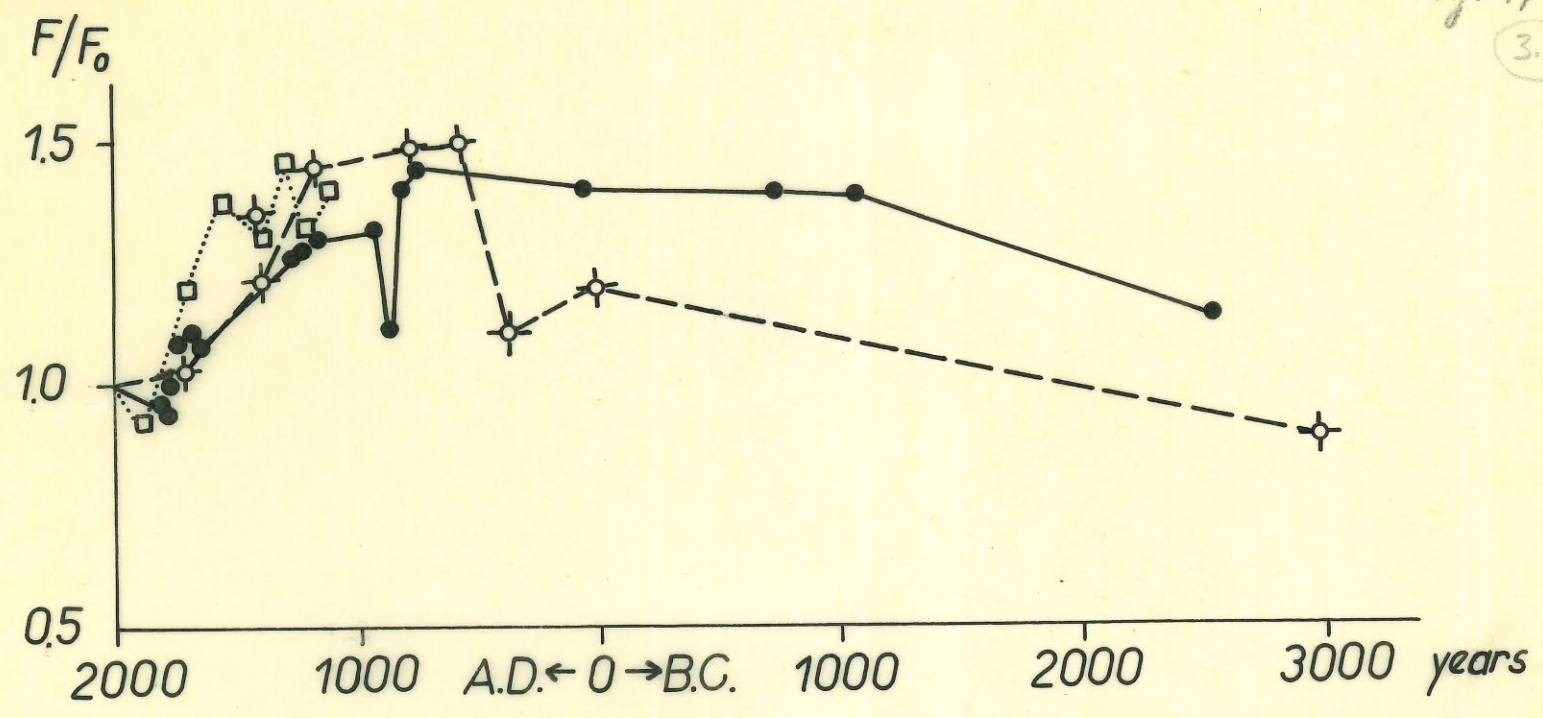

Fig. 17
3.8



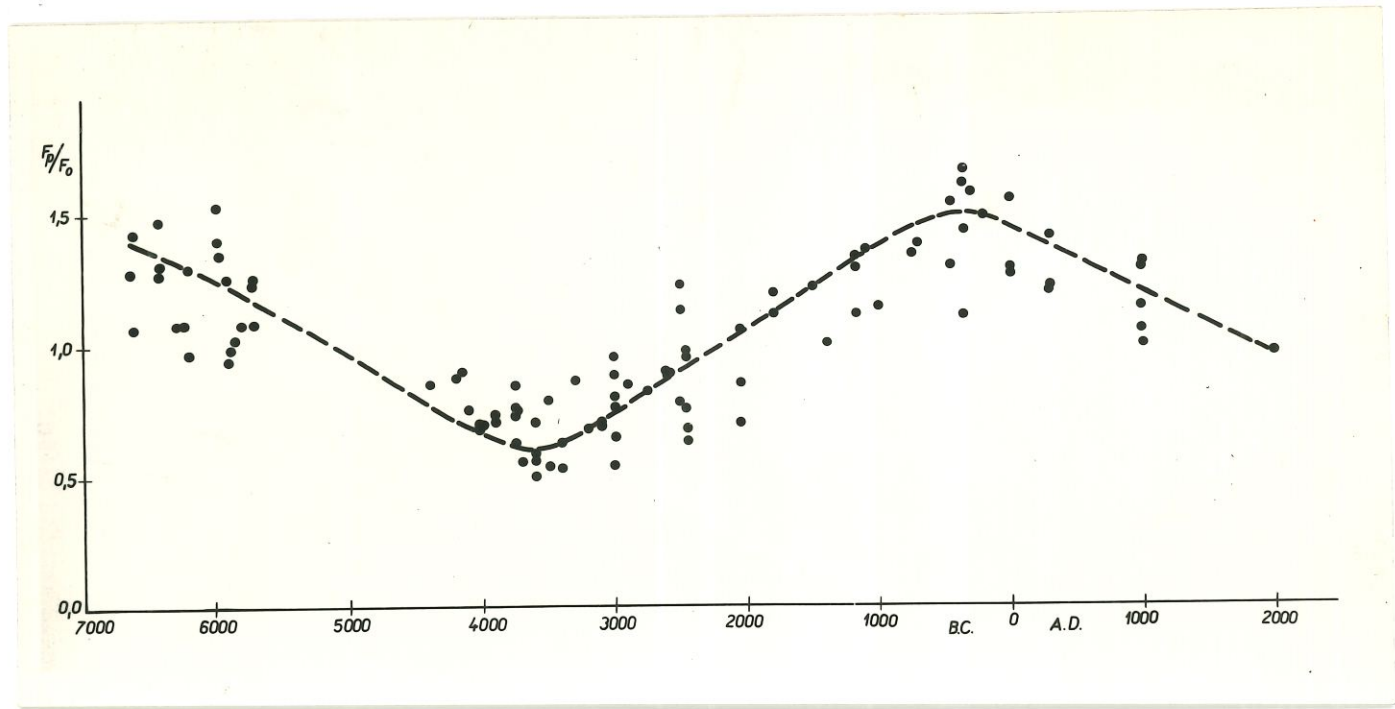

Fig. 3.10

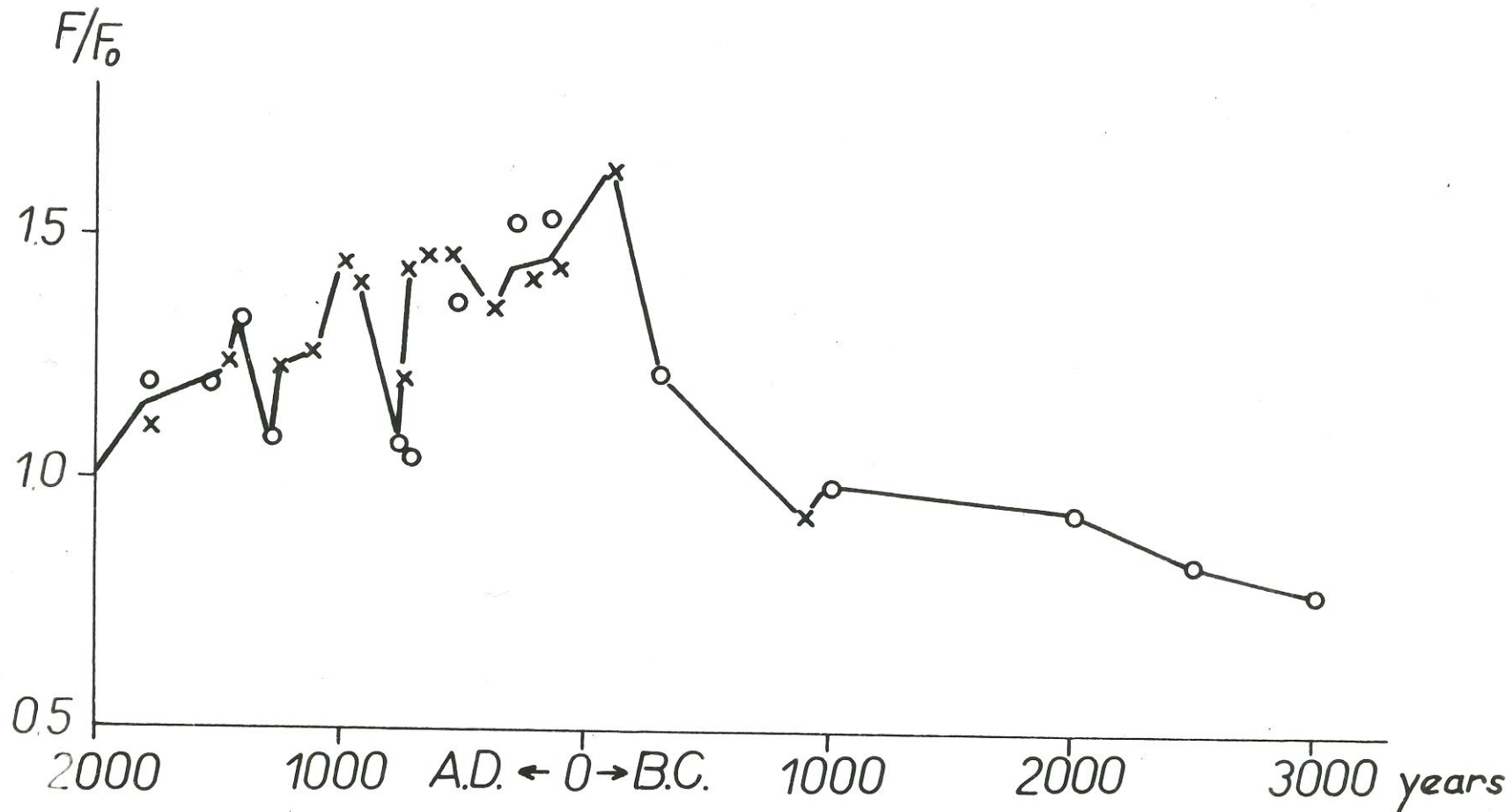

Fig. 3.9

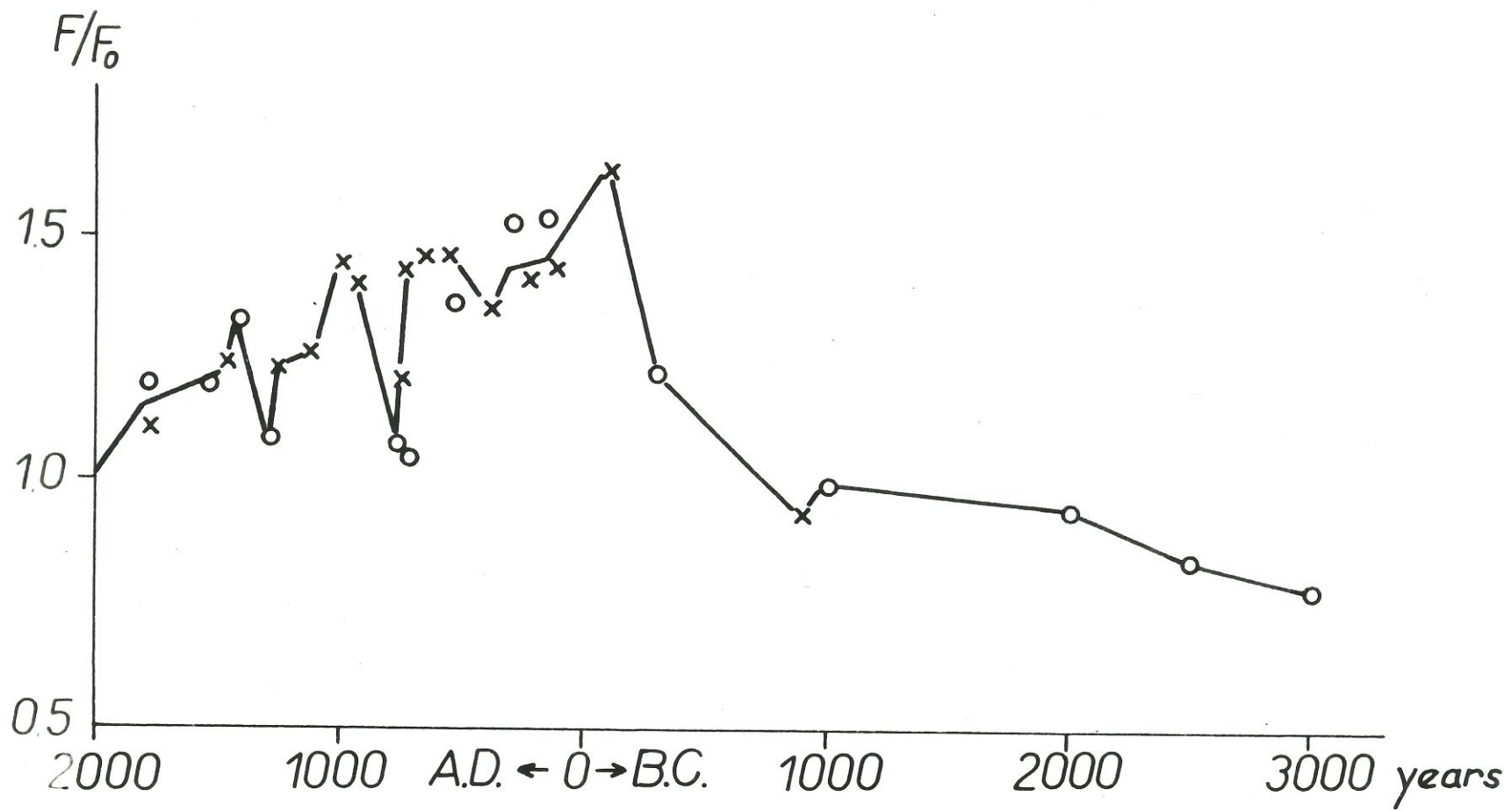

Fig. 3.9

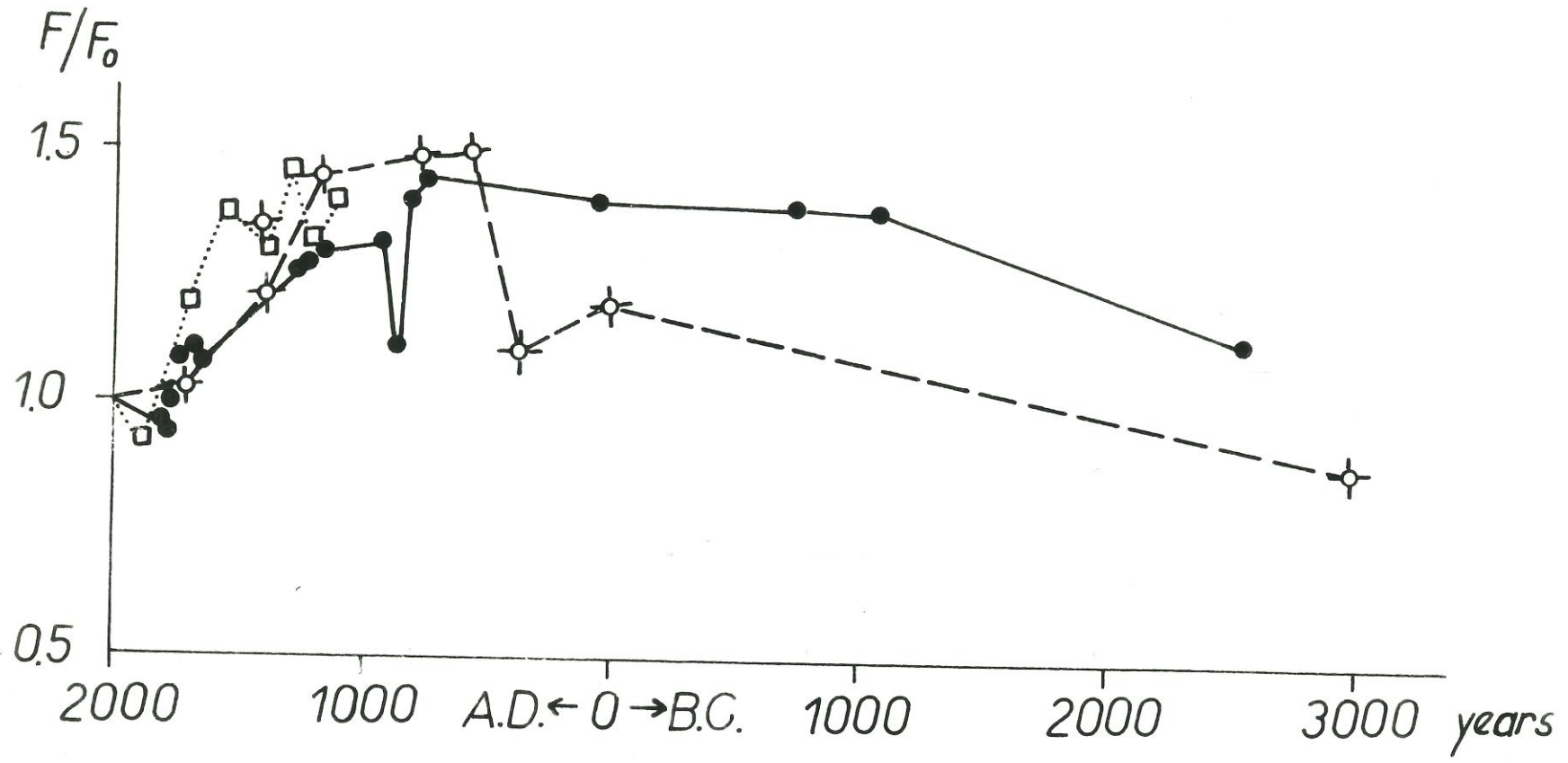

Fig. 3.8

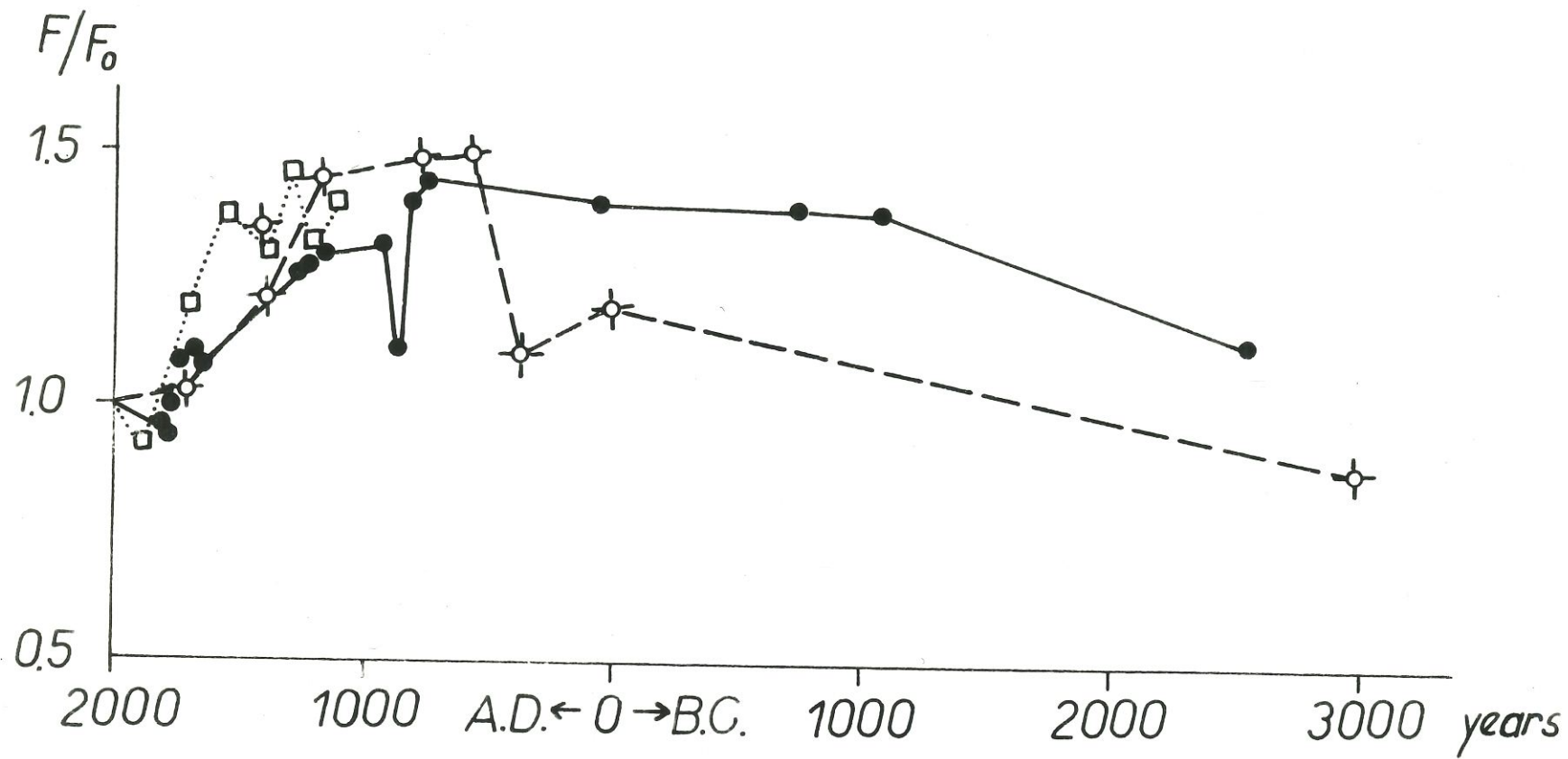
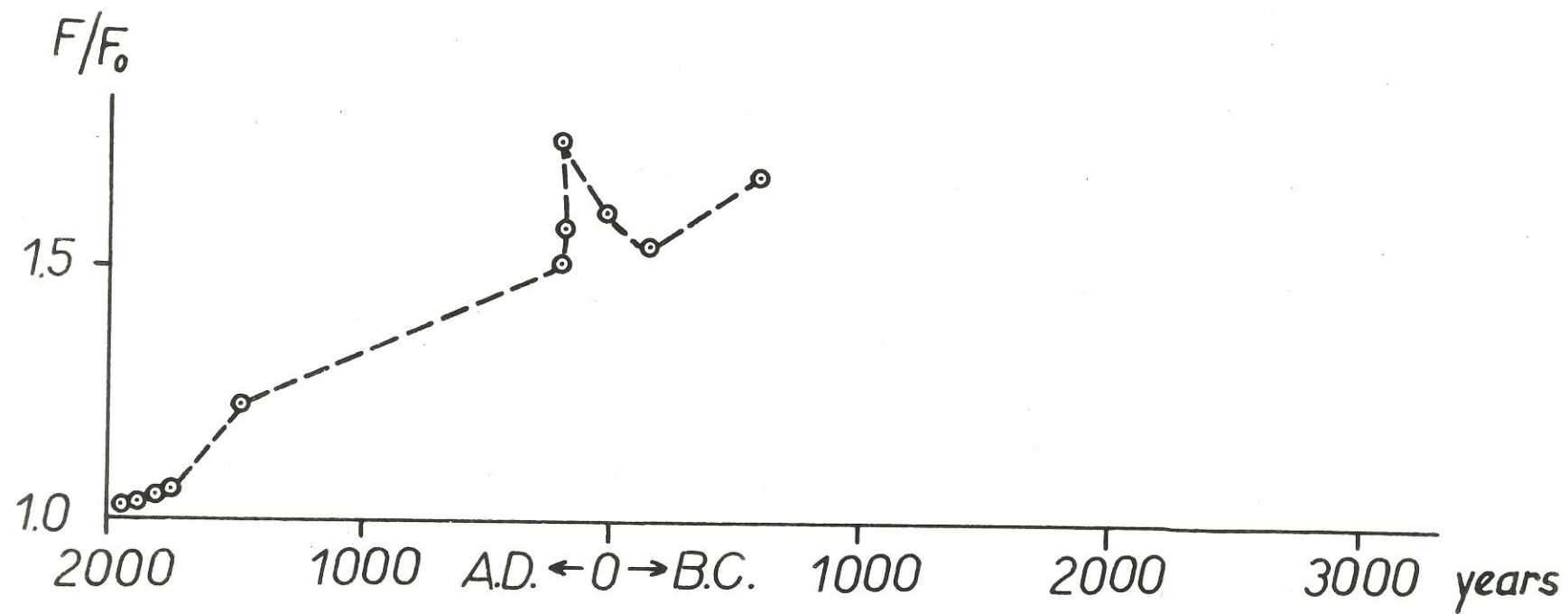

Fig. 3.8



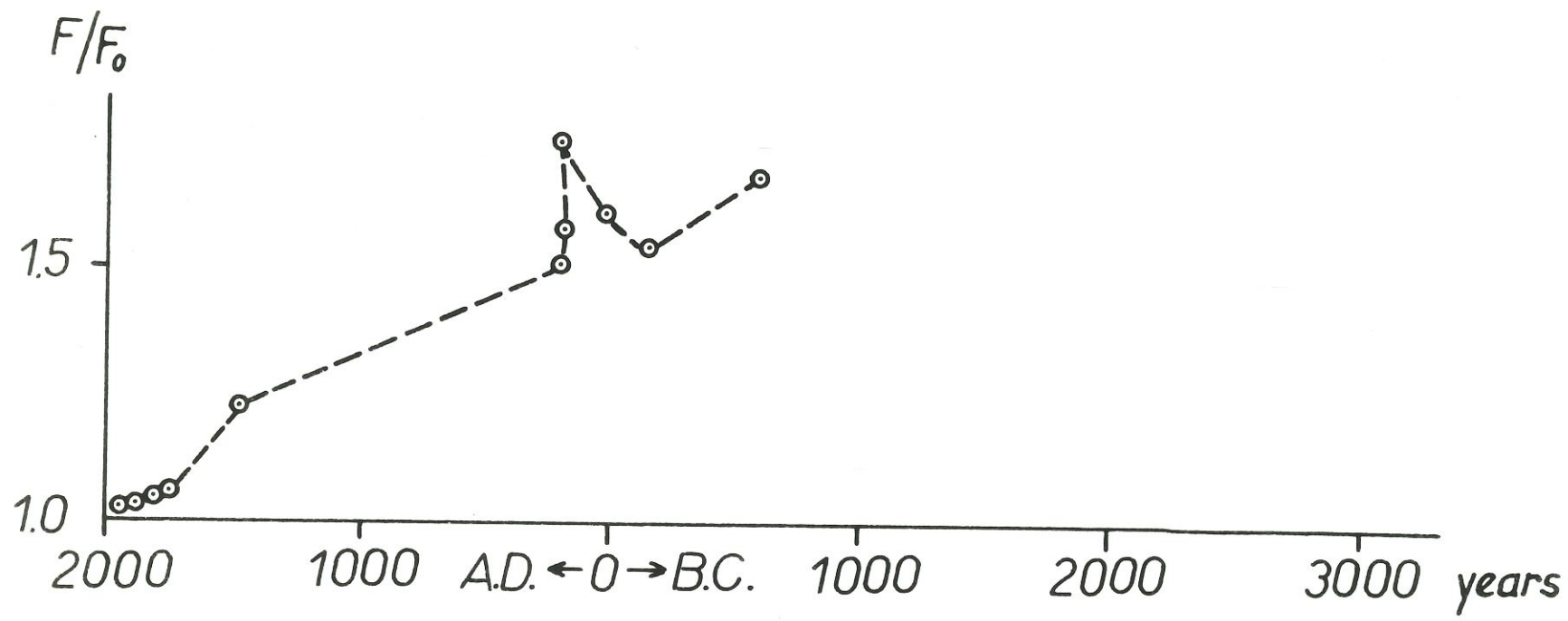

Fig. 3.7

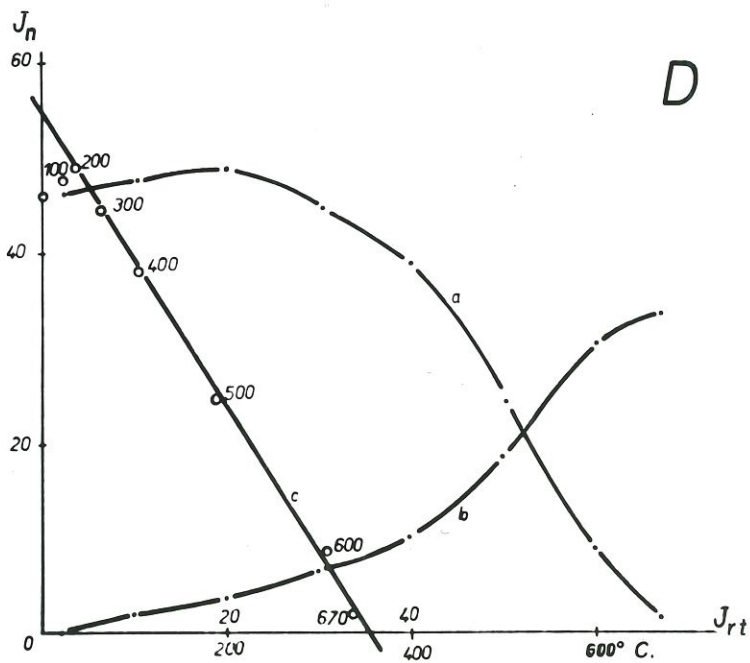
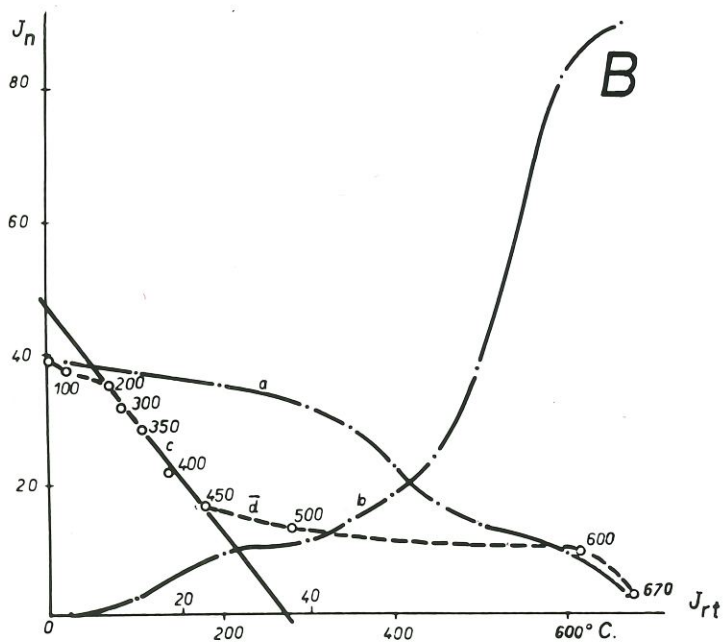
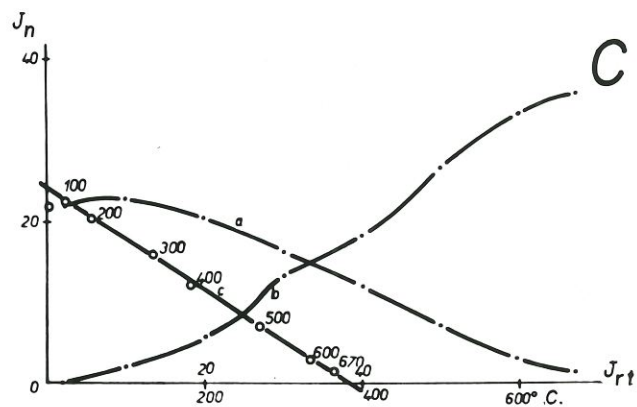
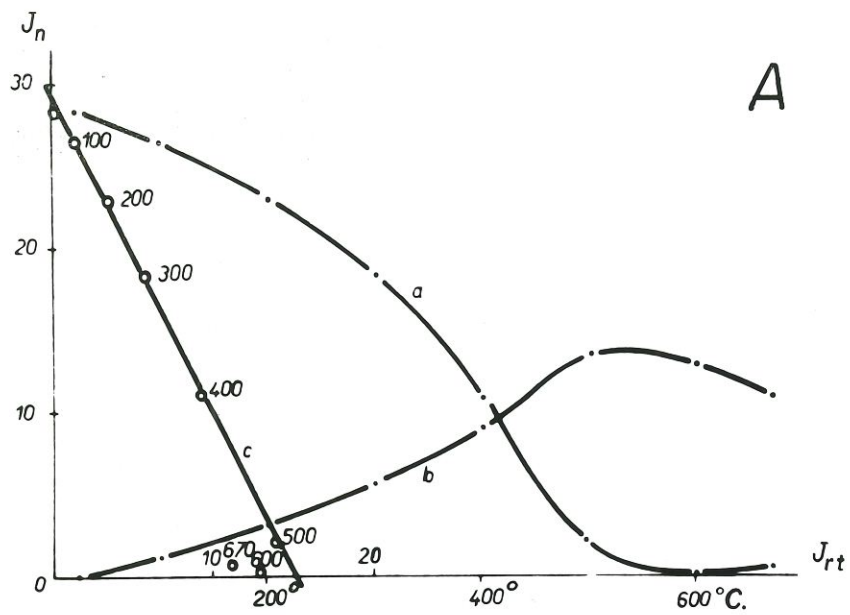

Fig. 3.18

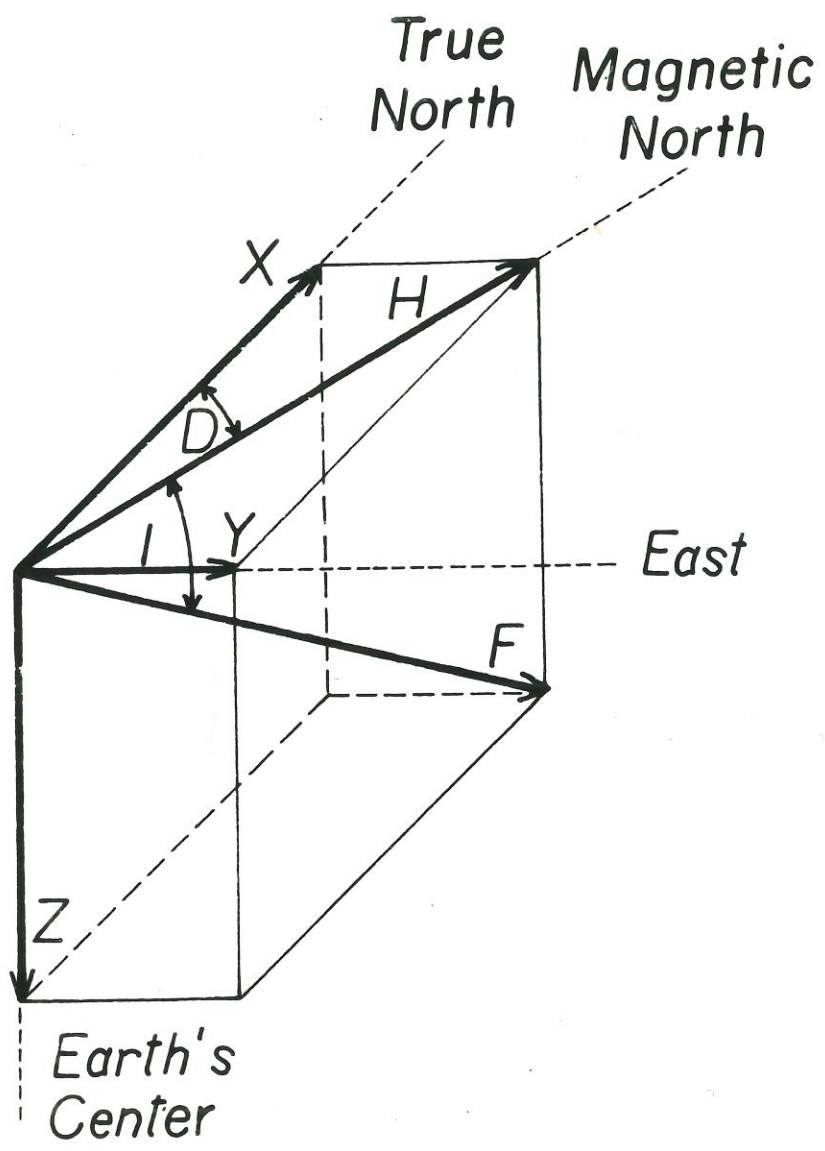

Fig. 3.22

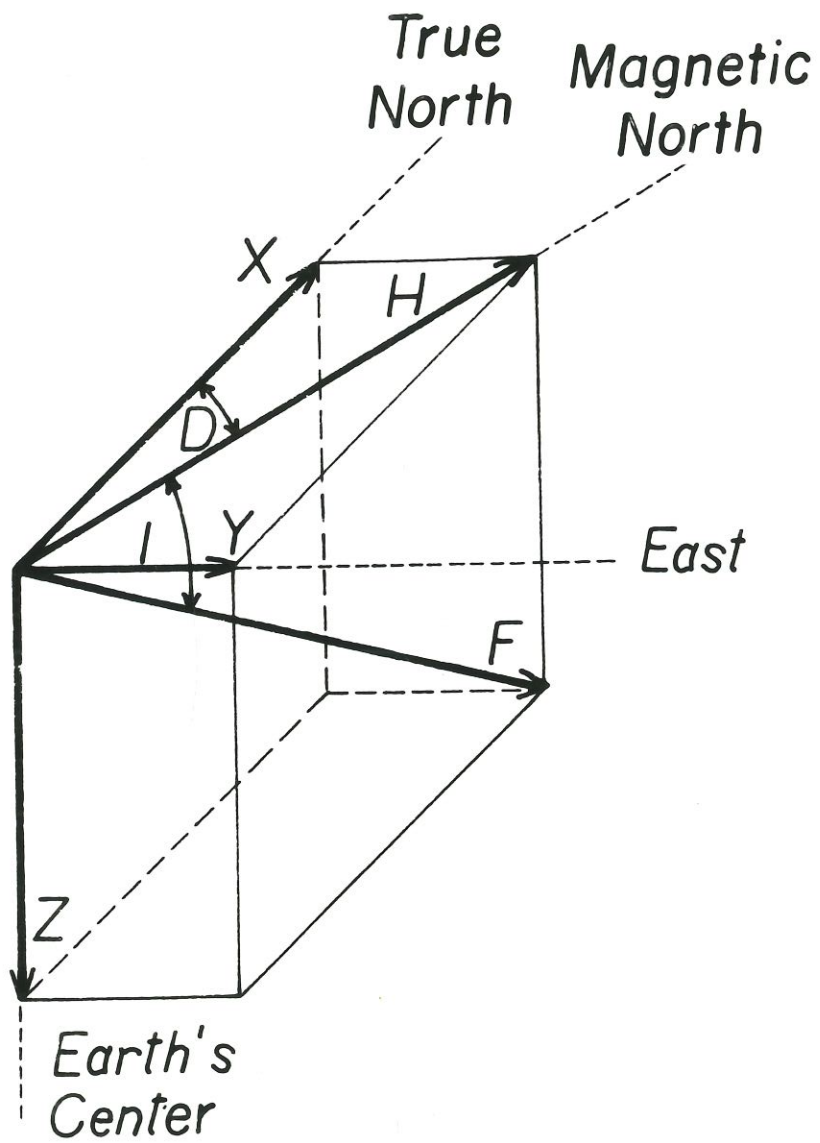

Fig. 3.22

BUCHA ORIGINAL FIGURES TO
CHAPTER 3

Bucha

Chapt. 3

extras (graphs, maps, illustrations)

3.V3

This is acceptable but a
really black print would
be preferable to this gray

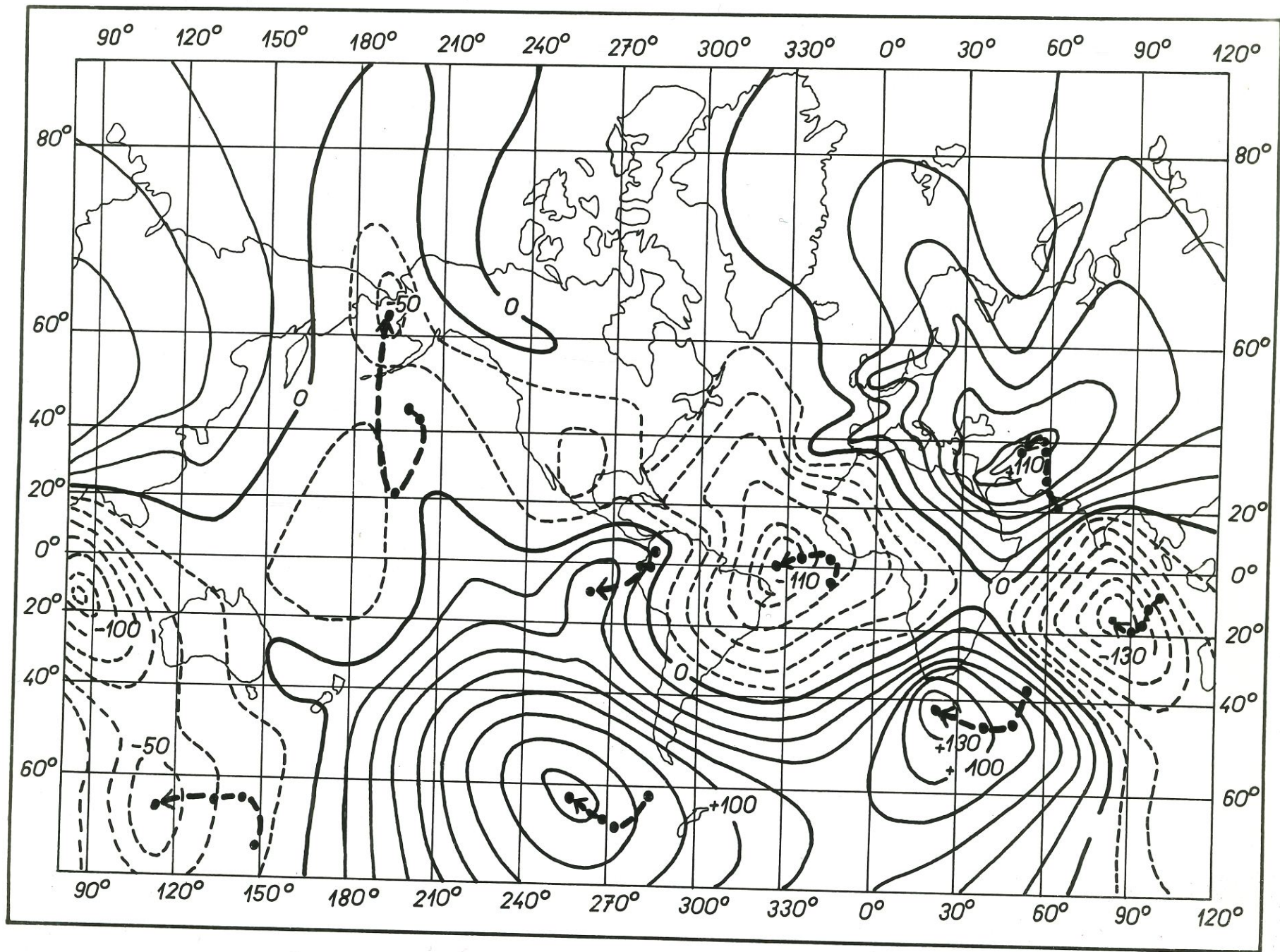

3.16 (Buclia)

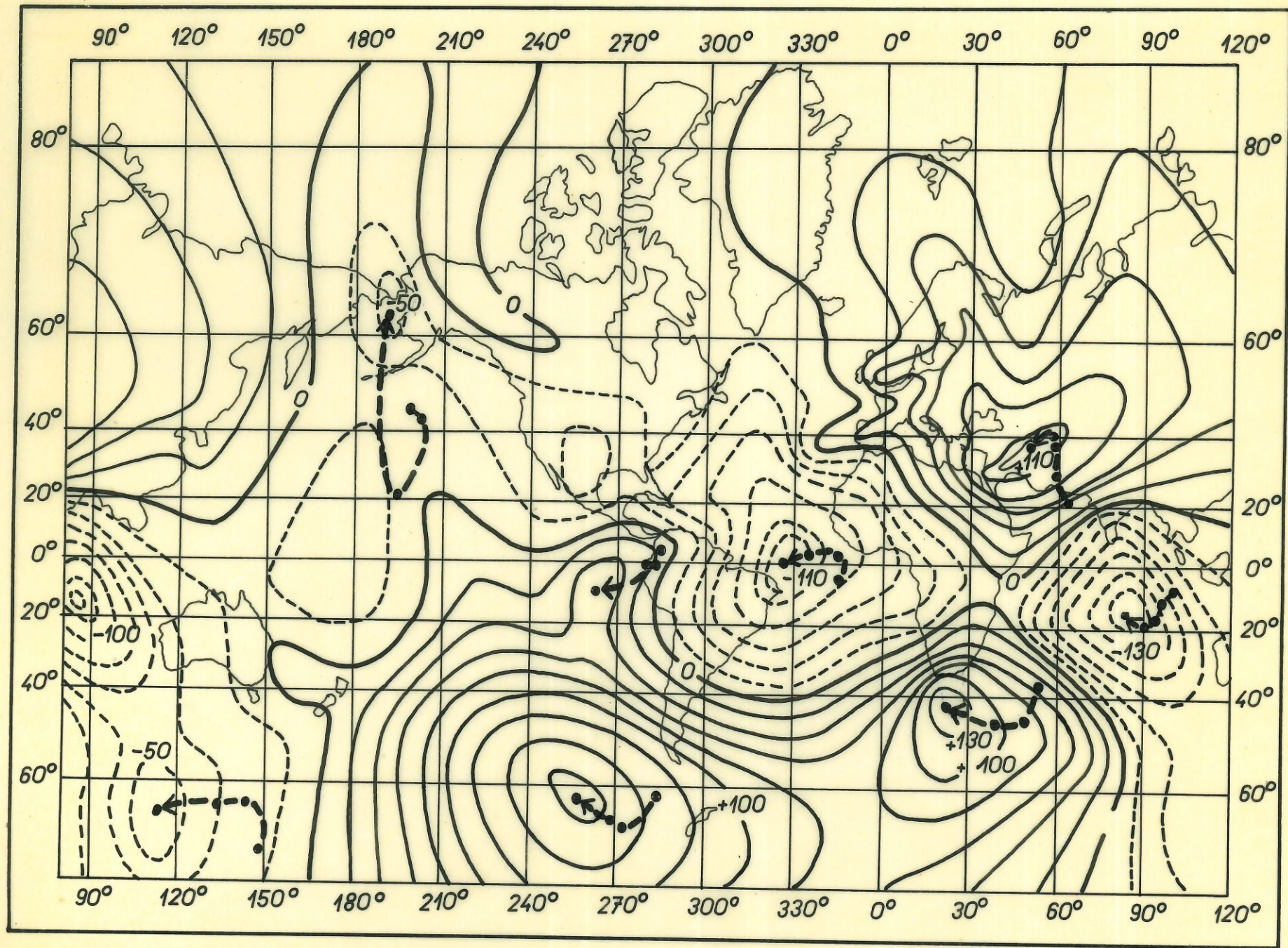
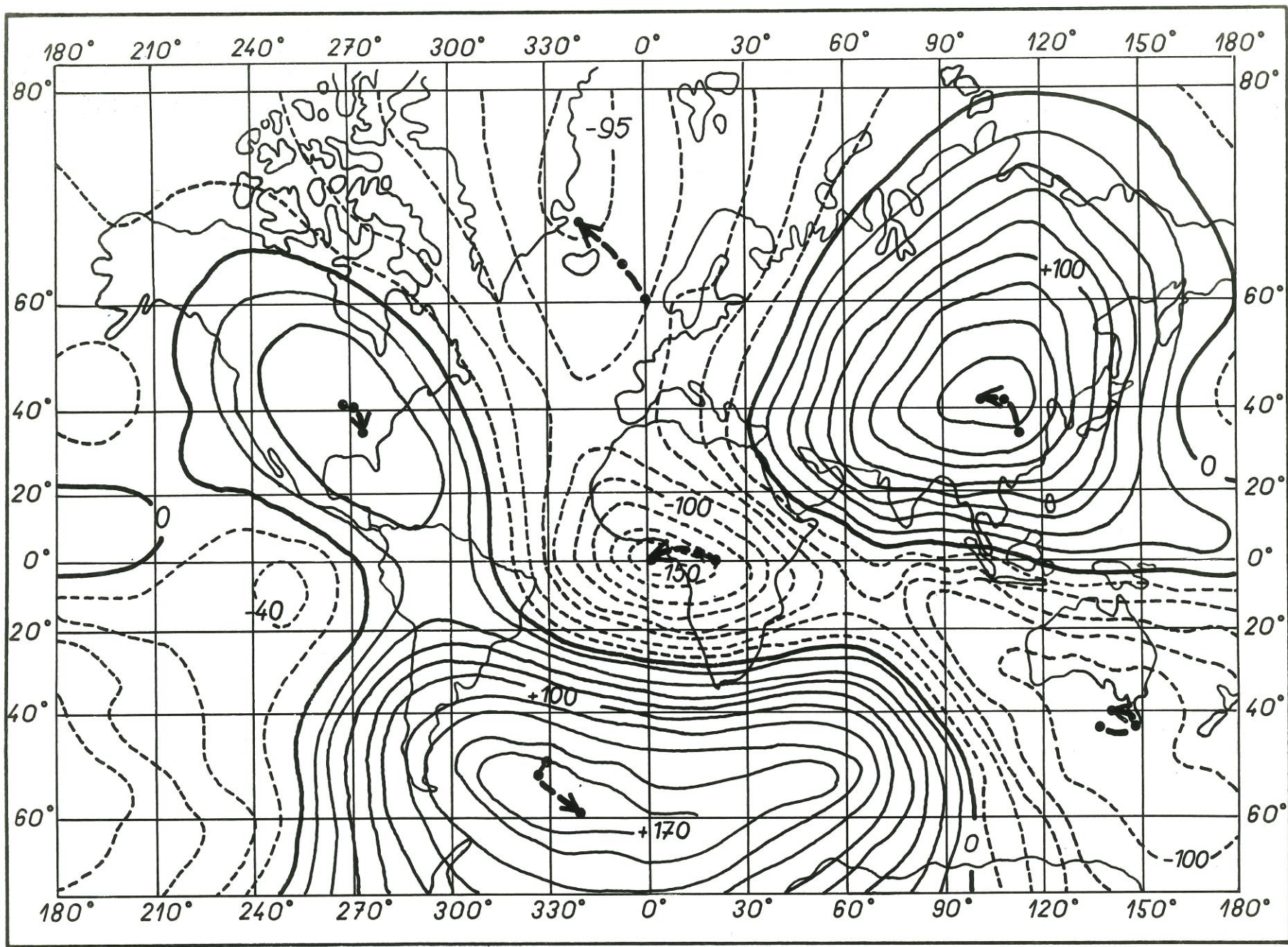

Fig. 3.16



3.2 (Buchs)

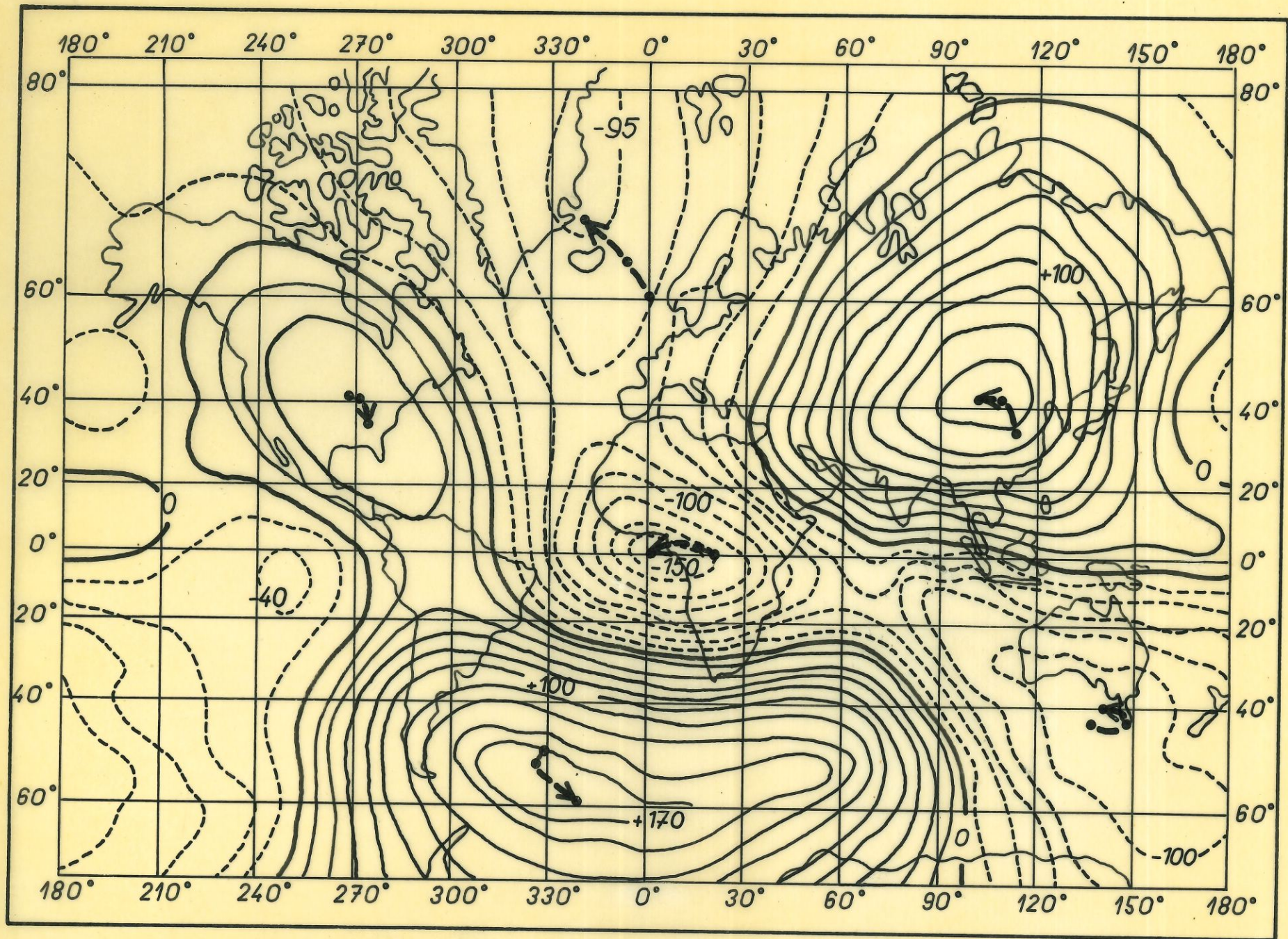
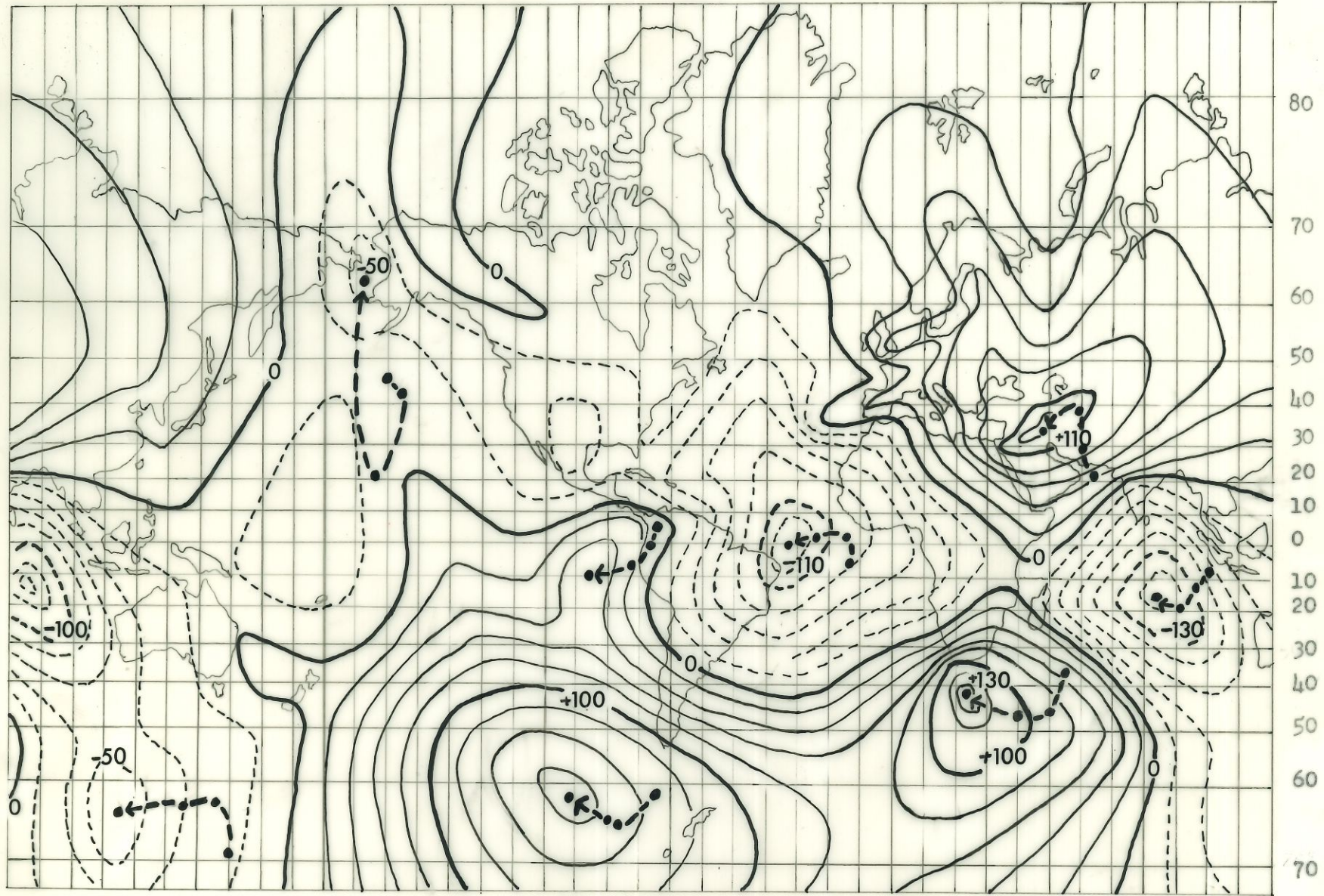
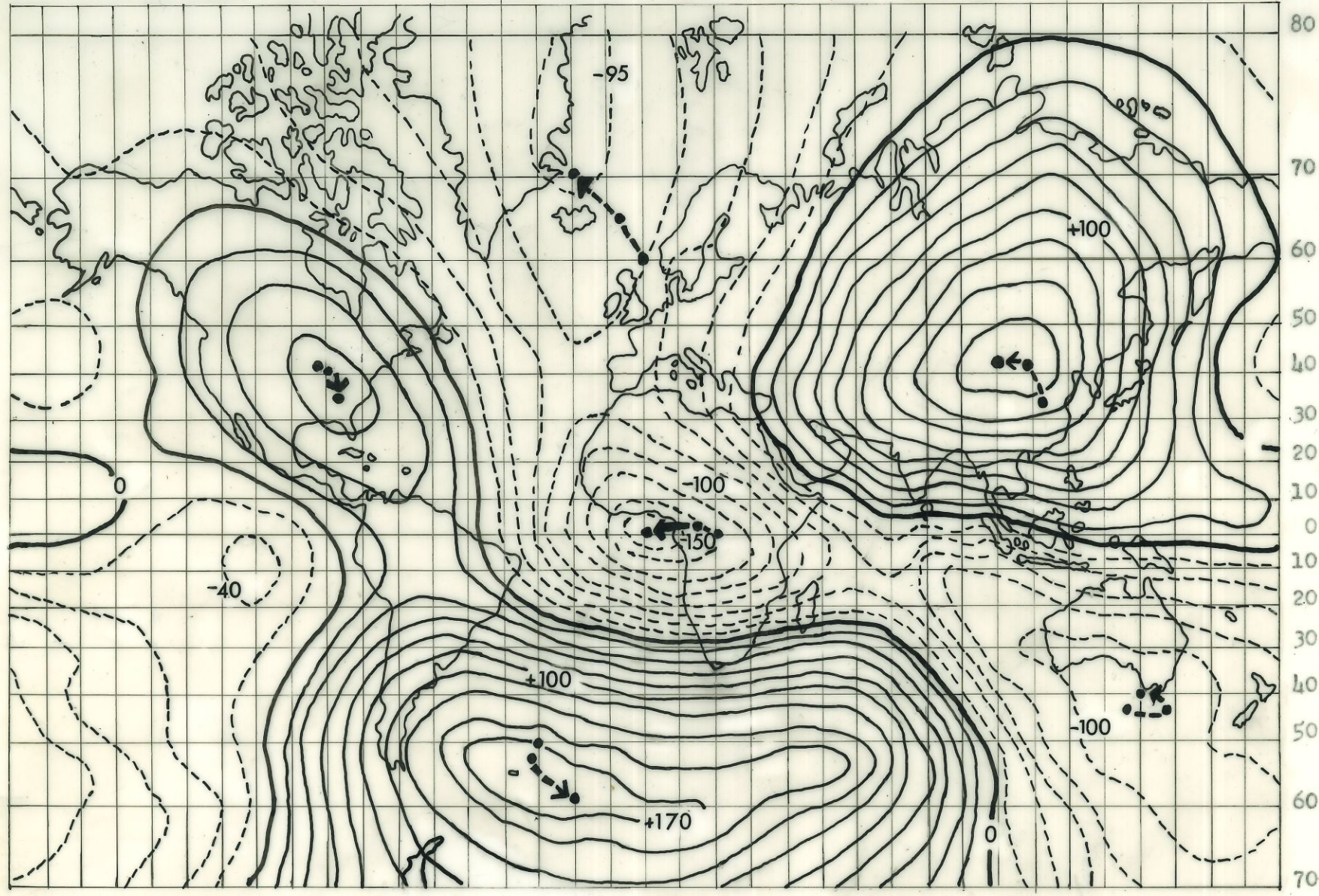

Fig. 3.2

80 100 120 140 160 180 200 220 240 260 280 300 320 340 0 20 40 60 80 100 120



180 200 220 240 260 280 300 320 340 0 20 40 60 80 100 120 140 160 180



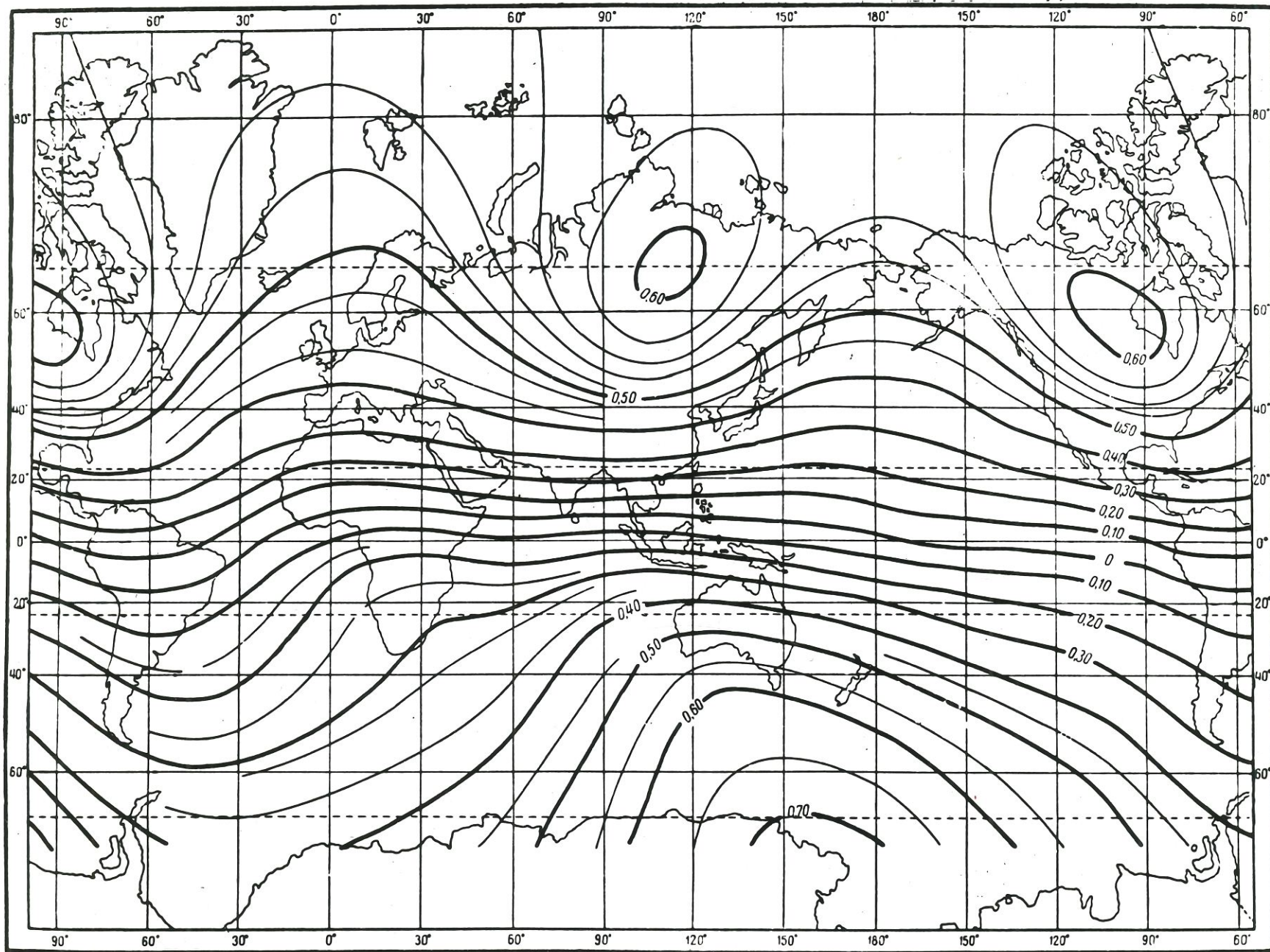

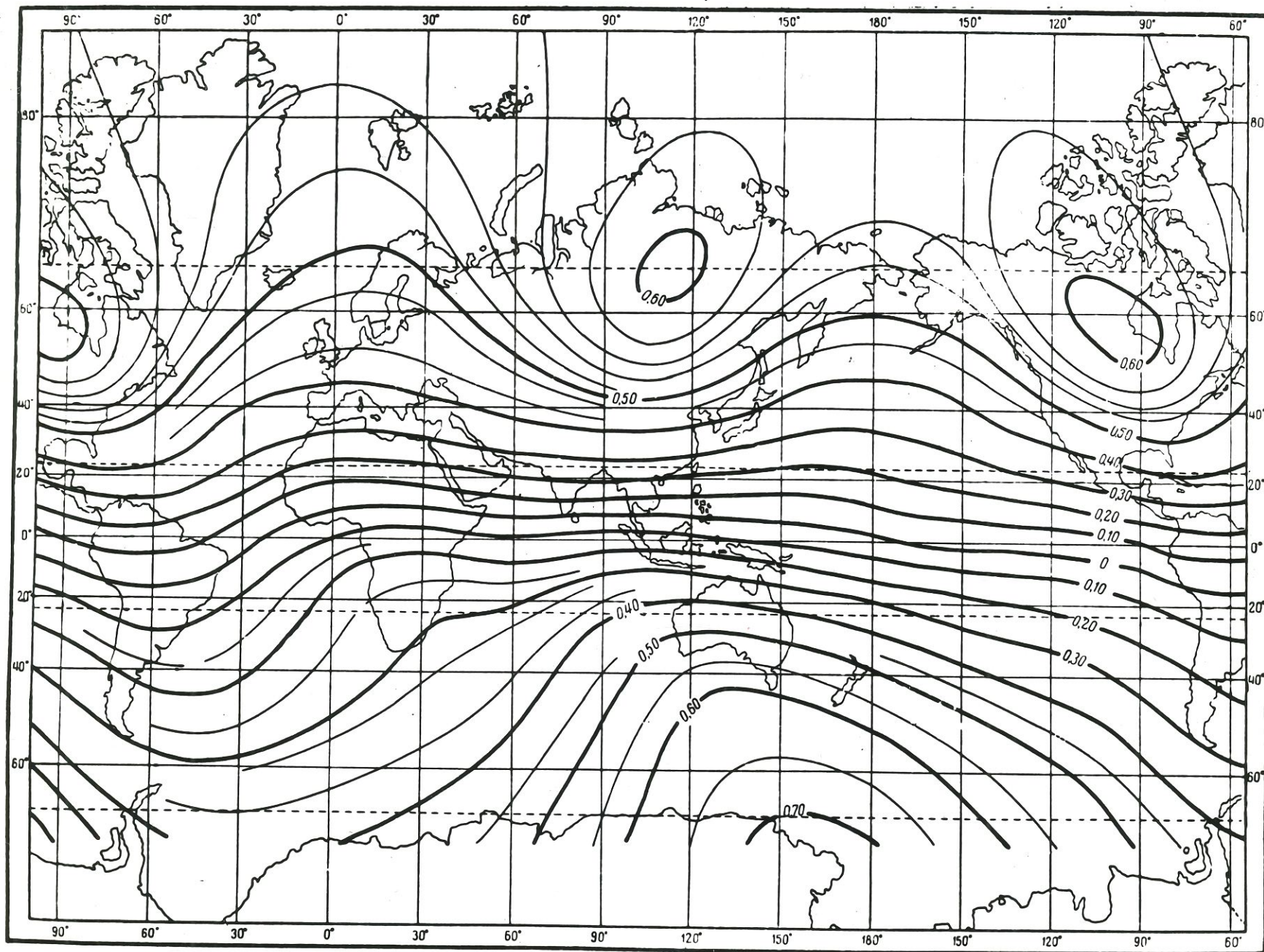

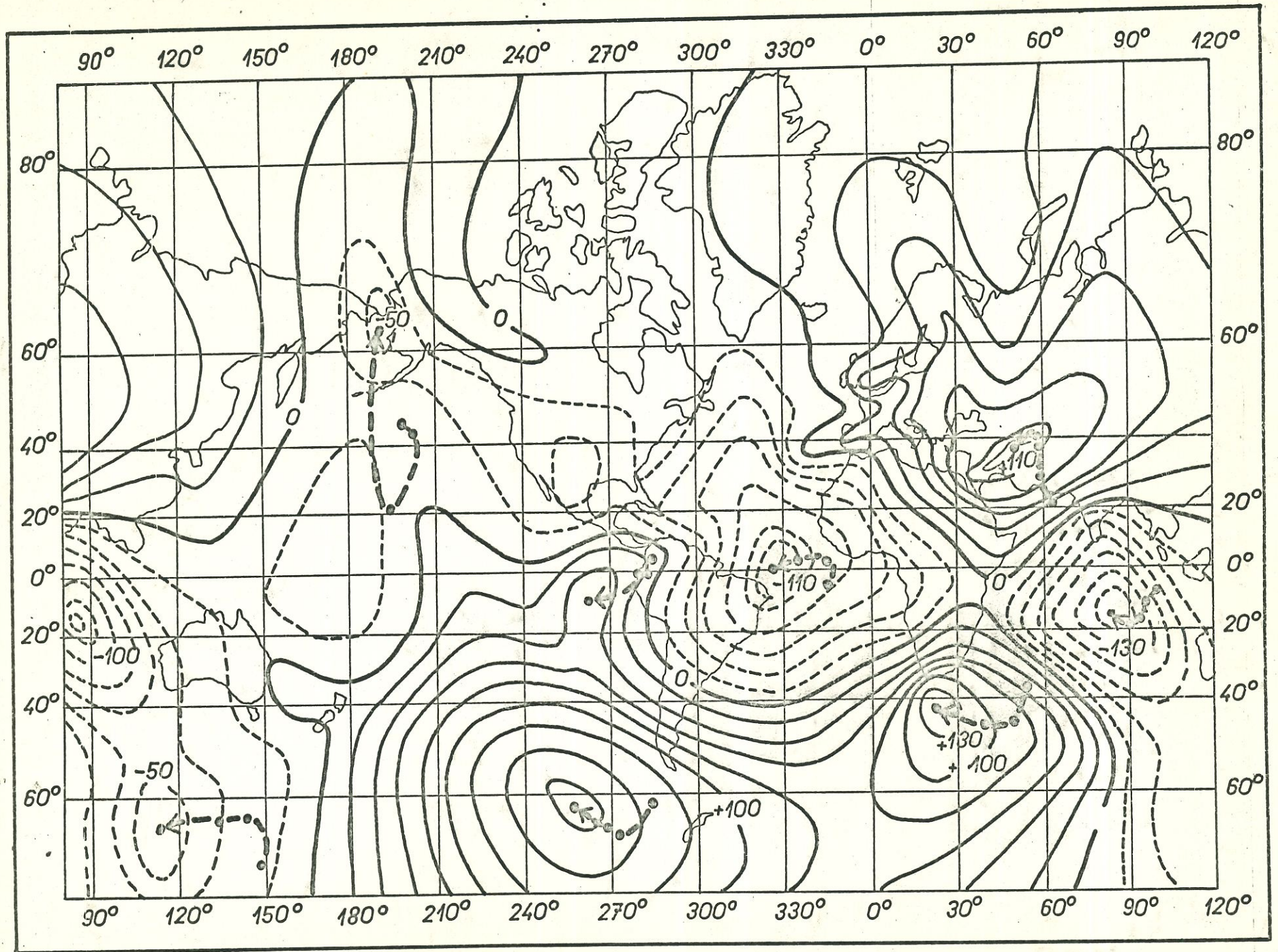

Fig. 3.16

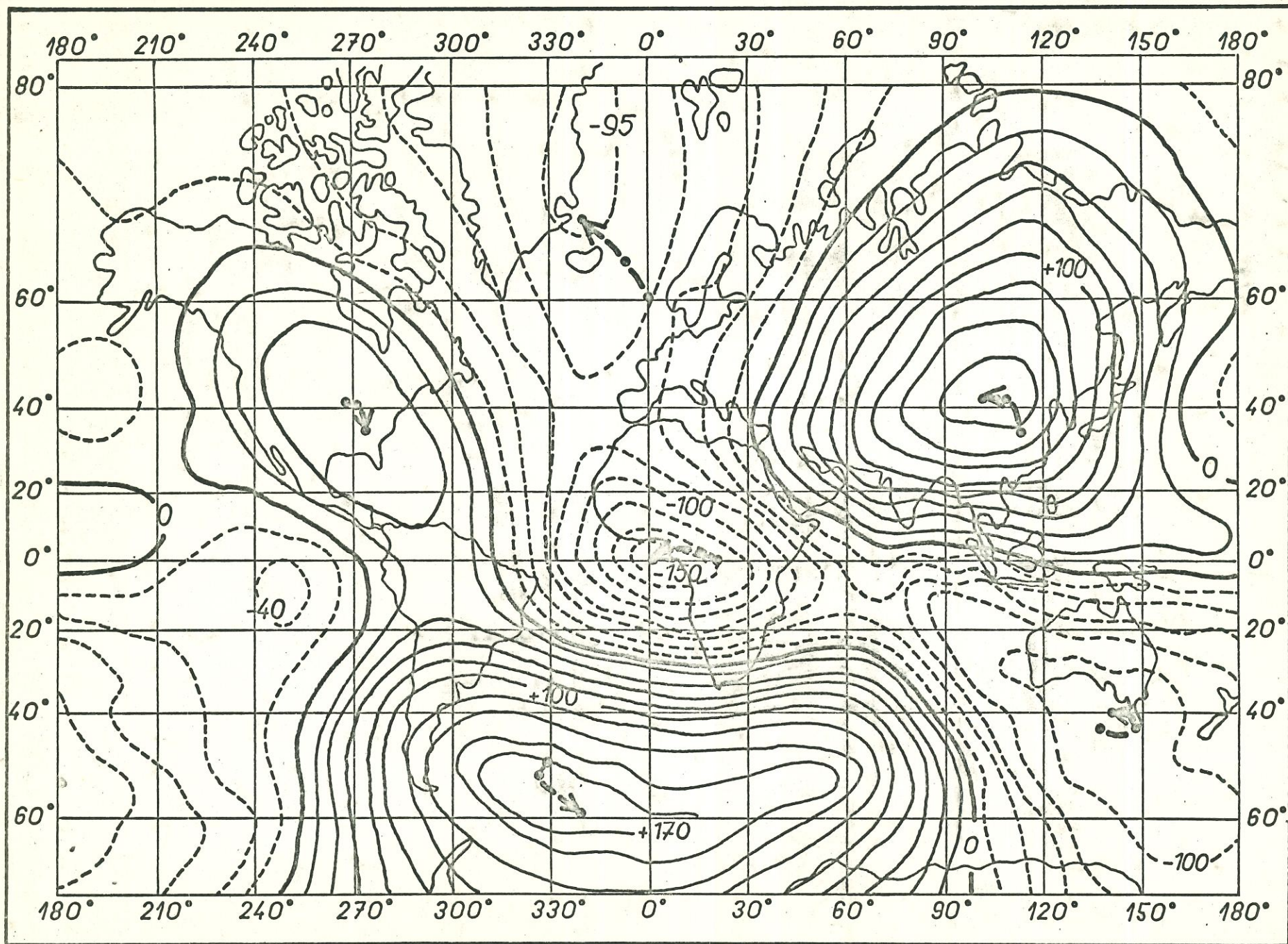
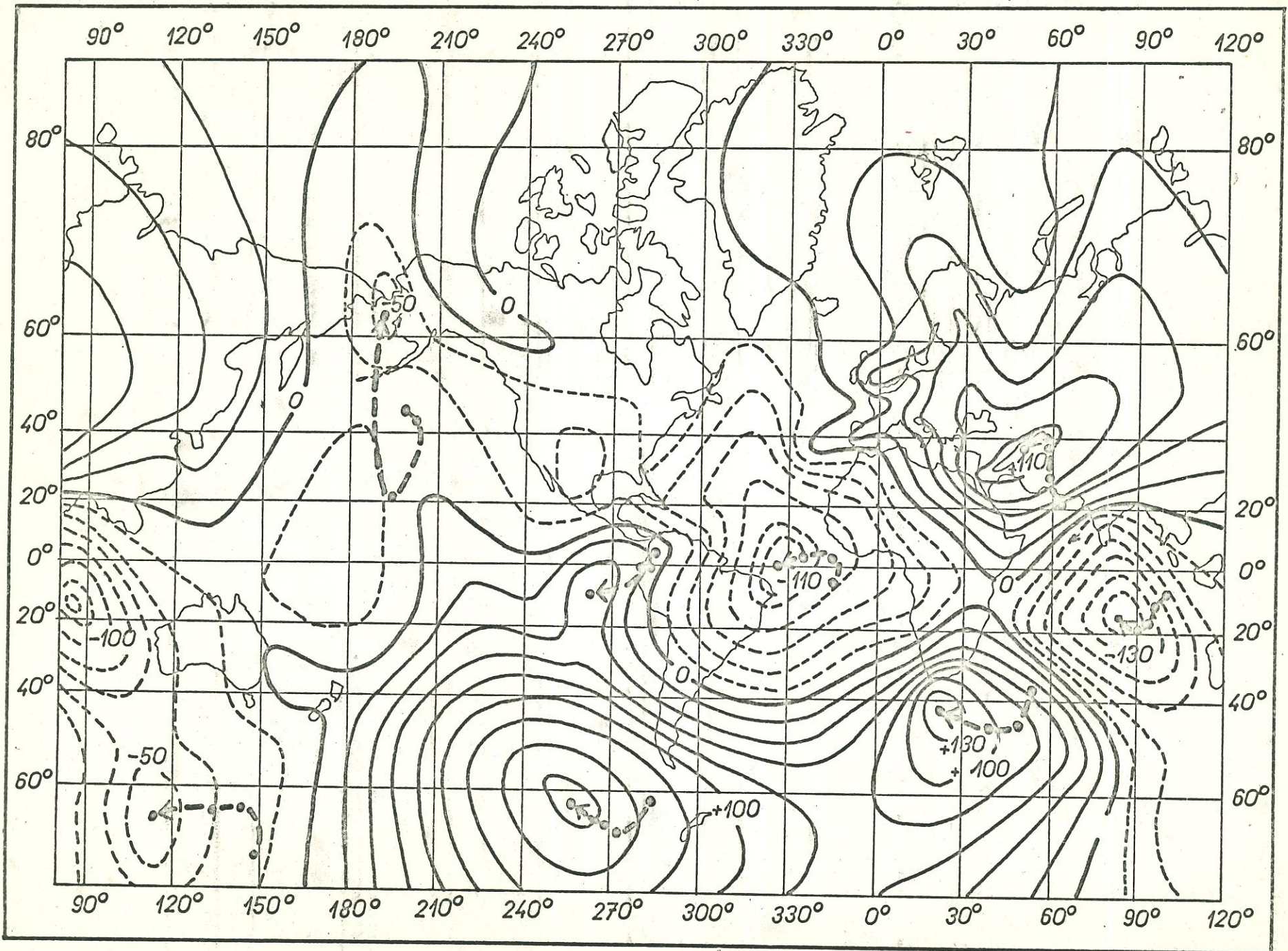

Fig. 3.2



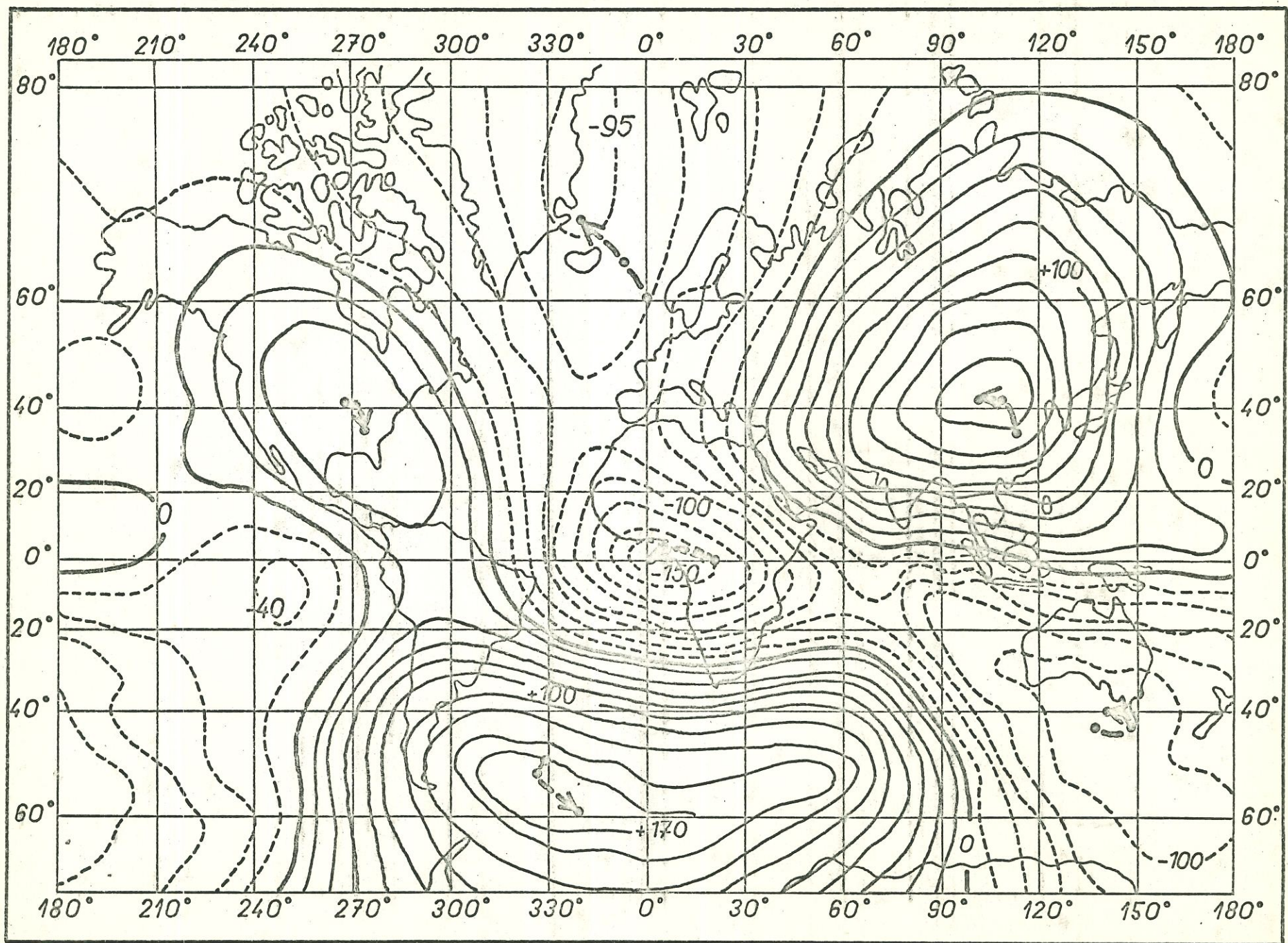

Fig. 3.2